

KBT9L4VN

Product familie	Dampkap
Type dampkap	Decoratieve muurdampkap
Type dampkap	T-vorm plat
Extractie	Extractie
Elektronische bediening	Ja
Materiaal	Inox
Type staal	Geborsteld inox
EAN-code	8017709305734
Breedte dampkap	90 cm







Design

Design	Universeel	Type glas	Zwart
Kleur	Inox en glas	Kleur serigrafie	Zwart
Afwerking	Geborsteld inox	Logo	Geëts

Bediening

			
Bediening	Touch bediening met witte LED	Display	Ja
LED kleur	Wit		

Programma's / Functies

Aantal snelheden	3
Snelheid Intensief	
Luchtzuiveringsfunctie (24 uur)	
Automatische uitschakeling	
Auto-Vent 2.0	

Technische specificaties



Aantal lampen	1	Aantal filters	3
Type lamp	LED	Vetfilters	Aluminium
Vermogen lamp	7.3 W	Indicator vervangen filter	Ja
Dimmerfunctie	Ja	Diameter ventilatie outlet	150 mm
Temperatuur licht aanpasbaar	3000° - 5700° °K	Minimum afstand van gaskookplaat	650 mm
Capaciteit P0	730 m ³ /h	Minimum afstand van elektrische kookplaat	500 mm
Vermogen motor	230 W	Terugslagklep	Ja

	Capaciteit niveau 1 (IEC 61591) [m ³ /h]	Geluidsniveau niveau 1 (IEC 60704-2-13) [dB(A)]
Snelheid 1	252	48
Snelheid 2	341	55
Snelheid 3	453	62
Snelheid Intensief	705	72

Meegeleverde accessoires

Reductie pijp	Ja
---------------	----

Prestaties / energielabel

A

Jaarlijkse energieconsumptie (AEC)	58 KWh/jaar	Akoestische A-gewogen geluidsemissie op maximum snelheid	62 dB(A)
Energie-efficiëntieklasse (EEC)	A	Akoestische A-gewogen geluidsvermogens in de lucht met intensieve snelheid	71 dB(A)
Hydrodynamische efficiëntieklasse (FDE)	30.5	Vermogensverbruik in Stand-by modus	0.42 W
Hydrodynamische efficiëntieklasse (FDEC)	A	Tijdverhogingsfactor (F)	0.9
Licht Efficiëntie (LE)	28.2 lux/W	Energie-efficiëntie Index	54.0
Licht Efficiëntieklasse (LEC)	A	Gemeten luchtdebiet op het beste efficiëntiepunt (Qbep)	385 m ³ /h
Vetfilter Efficiëntie (GFE)	73.7 %	Gemeten luchtdruk op het beste efficiëntiepunt (Pbep)	461 Pa
Vetfilter Efficiëntieklasse (GFEC)	D	Gemeten elektrisch vermogen op het beste efficiëntiepunt (Wbep)	161 W
Debiet luchtafvoer op minimum snelheid (Qmin)	252 m ³ /h		

Luchtstroom bij maximale snelheid (Qmax)	453 m ³ /h	Nominaal energieverbruik van de verlichting (WL)	7 W
Luchtstroom bij intensieve snelheid (Qboost)	705 m ³ /h	Gemiddelde verlichting op het kookoppervlak (Emiddle)	209 lux
Akoestische geluidsdruk op minimum snelheid (SPEmin)	46 dB(A)	Geluidsniveau bij de hoogste instelling (Lwa)	62 dB(A)

Elektrische aansluiting

Nominale aansluitwaarde	238 W	Frequentie	50-60 Hz
Spanning	220-240 V	Lengte voedingskabel	1500 mm

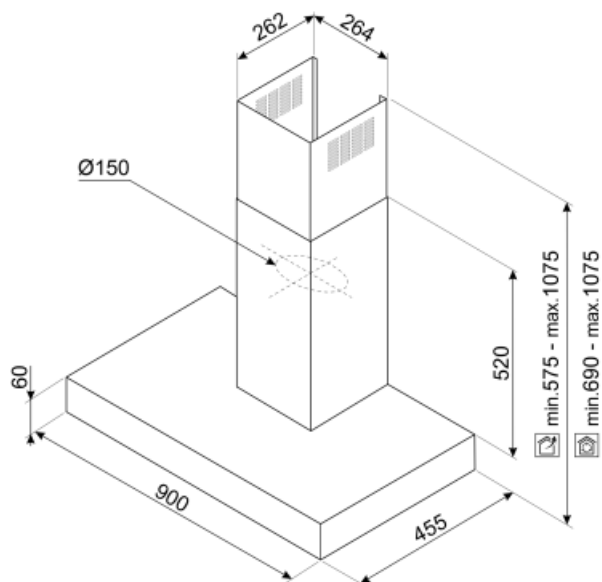

Not included accessories

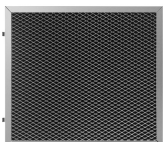

KITFCKBT

1 pcs di filtro a carboni attivi per i modelli di cappe KBT* / KBCT*

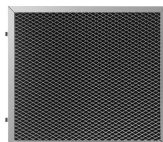

KITFCKBTR











1 pcs of Charcoal filter Regenerable* suitable for all the KBT/KBCT models.
* It can be washed in the dishwasher up to 12 times and dry in the oven at max 90° for 60 min. dimension 237,5(H)x245x10 mm



KITCEKBT

Chimney extension, dimensions 261,5 * 260 * 830 mm suitable for T-shape hood KBT* & KBCT*, max hight 1380 mm Stainless Steel

Symbols glossary (TT)

-  24h: When selected this function refreshes the air for c. 10 minutes every hour over a 24 hour period, at minimum speed and an imperceptible noise level.
-  Filters: Model has filters to help remove grease from the steam emanating from the pans during cooking.
-  LED display: to show programmes, functions and options selected and the time to the end of the cycle.
-  Lights: All cooker hoods feature lights to illuminate the cooking area or add to the ambience of the kitchen.
-  Connection between hob and hood
-  Tunable white from warm to cold
-  A: Product drying performance, measured from A+++ to D / G depending on the product family
-  Automatisch uitschakelen: Een speciale instelling, om na het einde van de bereiding een vooraf ingestelde tijd te laten lopen en daarna automatisch uit te schakelen.
-  Warning light(s): to advise when filters need changing.
-  Intensive/turbo setting: when extra fast extraction is required.
-  Dimmering Lights