

# SE484EMTD



Product familie	Kookplaat
Type	Vlak opbouw
Afmeting	80 cm
Voeding	Elektrisch
Type	Keramisch
EAN-code	8017709324247



## Design



Design	Universeel
Kleur	Zwart
Afwerking	Glas
Materiaal	Glas
Type glas	Keramisch
Glazen rand	Rechte rand
Bediening	Compact Slider bediening
Kleur LED	Rood
Positie bediening	Vooraan
Kleur serigrafie	Grijs

## Programma's / Functies



Totaal aantal kookzones	4
Aantal keramische kookzones	4
Aantal kookzones met booster	4
Hoofdtoets aan/uit	Ja
Vermogenniveaus	9

## Opties



Worktop Cut-Out	490x745 mm	ECO-Logic optie	Ja
-----------------	------------	-----------------	----

<b>Warmhoudfunctie</b>	Ja	<b>Beperkt vermogensverbruik</b>	2800, 4000 W
<b>Automatische uitschakeling</b>	4	<b>Showroom demo optie</b>	Ja
<b>Timer</b>	1	<b>Kinderbeveiliging</b>	Ja
<b>Geluidssignaal einde kooktijd</b>	Ja	<b>Quick start</b>	Ja
<b>Resttijd indicator</b>	Ja		

## Technische specificaties



Linksvoor - Keramisch - dubbel - 2.30 kW - Ø 21.0 cm  
 Linksachter - Keramisch - enkel - 1.20 kW - Ø 15.0 cm  
 Rechtsachter - Keramisch - uitbreidbaar - 2.20 kW - Ø 17.0 cm  
 Rechtsvoor - Keramisch - enkel - 1.80 kW - Ø 18.5 cm

<b>Automatisch uitschakelen i.g.v. oververhitting</b>	Ja	<b>Restwarmte indicator</b>	Ja
<b>Automatisch uitschakelen i.g.v. overkoken</b>	Ja		

## Elektrische aansluiting

<b>Nominale aansluitwaarde</b>	7400 W	<b>Type stroomkabel</b>	Eenfasig en tweefasig
<b>Stroom</b>	22 A	<b>Frequentie</b>	50/60 Hz
<b>Spanning (V)</b>	220-240 V	<b>Lengte voedingskabel</b>	150 cm
<b>Spanning 2 (V)</b>	380-415 V	<b>Aansluiting</b>	6 polig

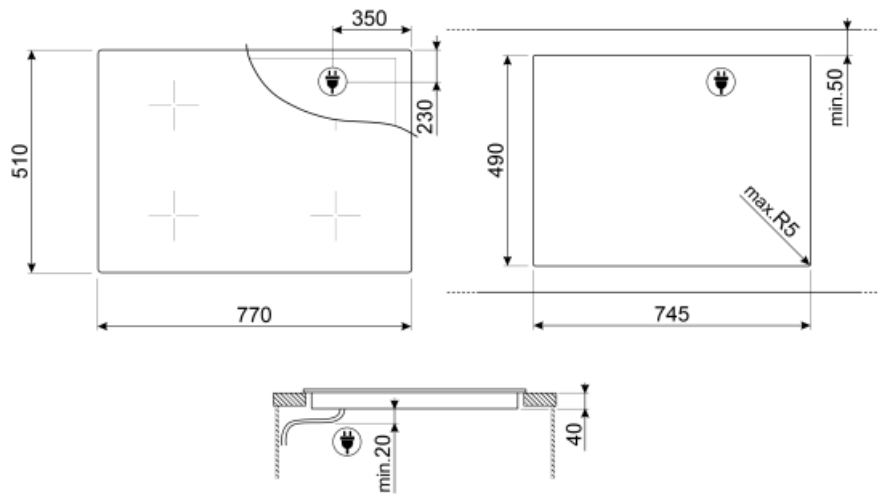

## Not included accessories













---



**SCRP**

Schraper voor inductie- en vitrokeramische kookplaten

## Symbols glossary (TT)

 <p>Power booster: option allows the zone to work at full power when very intense cooking is necessary.</p>	 <p>Ultra-low profile: Installation of product with flat edge - height of 1 mm.</p>
 <p>Sommige modellen zijn voorzien van een functie om het programma/de cyclus te blokkeren zodat het niet per ongeluk kan aangepast worden.</p>	 <p>ECO-logic: option allows you to restrict the power limit of the appliance real energy saving.</p>
 <p>This function allows you to keep cooked food warm without burner it</p>	 <p>Overheat protection: The safety system that automatically turns off the hob in case of overheating of the control unit.</p>
 <p>Glass ceramic: The base of the hob is made glass ceramic. Heating is performed by the heating elements Hi-Light.</p>	 <p>Overfill protection: The special overfill protection shuts down the stove in the presence of overflow of liquids.</p>
 <p>Quick Start function: the chosen temperature is reached faster. The heating element works at maximum power until the right temperature is reached.</p>	 <p>Indication of residual heat: After the glass ceramic hob is switched off the residual heat indicator shows which of the heating zones still remains hot. When the temperature drops below 60 ° C, the indicator goes out.</p>
 <p>Time elapsed: shows how long the cooking zone has been in use.</p>	 <p>Timer: All ceramic hobs have a timer which automatically ends cooking after a preset time.</p>
 <p>Compact Slider intuitive and easy to use</p>	