

SF6400TB



Category	60cm
Product Family	Oven
Power supply	Electric
Heat source	ELECTRICITY
Cooking method	Thermo-ventilated
Cleaning system	Vapor Clean
EAN code	8017709324902



Aesthetics

Aesthetic	Selezione	Serigraphy colour	Grey
Colour	Black	Serigraphy type	Symbols
Finishing	Glossy	Door	Full glass
Design	Flat	Handle	Selection squared
Material	Glass	Handle Colour	Black
Type of steel	Brushed	Logo	Silk screen
Glass Type	Clear		









Controls

			
Display name	DigiScreen	No. of controls	2
Display technology	LED	Control knobs	Cucina restyling
Control setting	Knobs & touch buttons	Controls colour	Black

Programme / Functions

No. of cooking functions 8

Traditional cooking functions

 Static	 Fan assisted	 Circulaire
 Turbo	 Eco	 Large grill
 Fan grill (large)	 Base	

Other functions

 Defrost by time

Cleaning functions

 Vapor Clean

Options



Time-setting options Delay start and automatic end cooking
Minute minder Yes

Timer 1
Rapid pre-heating Yes

Technical Features



Minimum Temperature 50 °C
Maximum temperature 250 °C
No. of shelves 5
Shelves type Metal racks
N. of fans 1
No. of lights 1
Light type Halogen
User-replaceable light Yes
Light Power 40 W
Light when door is opened Yes
Lower heating element power 1200 W
Upper heating element - Power 1000 W
Grill element - power 1700 W
Large grill - Power 2700 W
Circular heating element - Power 2000 W

Heating suspended when door is opened Yes
Door opening type Standard opening
Door Temperate door
Removable door Yes
Full glass inner door Yes
Removable inner door Yes
Total no. of door glasses 3
Safety Thermostat Yes
Chimney Fixed
Cooling system Tangential
Cooling duct Single
Speed Reduction Cooling System Yes
Usable cavity space dimensions (HxWxD) 360x460x425 mm
Temperature control Electro-mechanical
Cavity material Ever clean Enamel

Performance / Energy Label



Energy efficiency class A
Net volume of the cavity 70 l
Energy consumption per cycle in conventional mode 1.15 KWh
Energy consumption in conventional mode 4.14 MJ

Energy consumption in forced air convection 2.88 MJ
Energy consumption per cycle in fan-forced convection 0.80 KWh
Number of cavities 1
Energy efficiency index 95.2 %

Accessories Included

Rack with back stop 1

Enamelled deep tray (40mm) 1

Electrical Connection

Voltage 220-240 V
Current 13 A
Nominal power 3000 W

Frequency (Hz) 50/60 Hz
Power supply cable length 115 cm

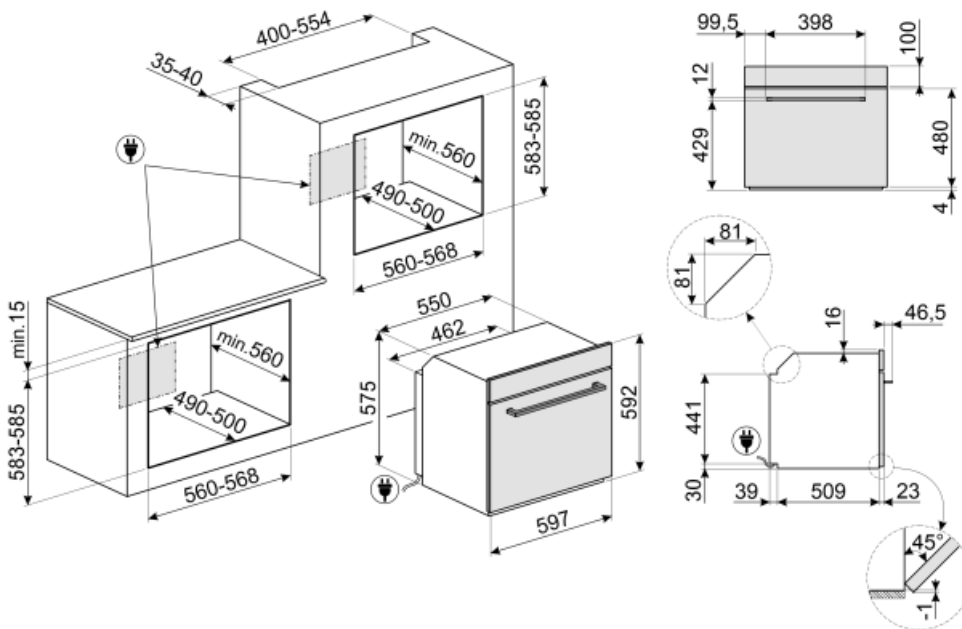

Not included accessories

GTP

Partially extractable telescopic guides (1 level), suitable for traditional ovens. Made in stainless steel, they guarantee stability and facilitate the smooth extraction of the trays.



PRTX

Refractory pizza stone with handles. D=35cm Not suitable for microwave ovens. Suitable for gas ovens, to be put on the griddle.



GT1P-2

Partially extractable telescopic guides (1 level) for ovens with metal frames. Length: 355.5 mm, extraction: 285 mm. Material: Stainless steel AISI 430 polished.



GTT

Totally extractable telescopic guides (1 level), suitable for traditional ovens. Made in stainless steel, they guarantee stability and facilitate the smooth extraction of the trays.



PR3845X

Antifingerprint stainless steel. Cover for furniture in column installation of more ovens



BN620-1

Enamelled tray suitable for 45cm and 60cm ovens. Depth 20 mm. Perfect for a wide range of savoury and sweet baking.



PALPZ

Pizza shovel with folding handle. Dimensions L31.5 x H32.5 cm. Easy and convenient to use and store. Perfect for serving pizza, bread and savory pastries in a safe and professional way.



















BN640

Enamelled tray suitable for 45cm and 60cm ovens. Depth 540 mm. Perfect for cooking and roasting meat and fish in sauces. Also ideal for experimenting with lighter and crunchy side dishes



Symbols glossary (TT)

 <p>A: Product drying performance, measured from A+++ to D / G depending on the product family</p>	 <p>Air cooling system: to ensure a safe surface temperatures.</p>
 <p>Defrost by time: Manual defrost function. At the end of the set duration, the function stops.</p>	 <p>Triple glazed doors: Number of glazed doors.</p>
 <p>Electric</p>	 <p>Ever Clean Enamel: Ever Clean enamel is applied electrostatically, corner to corner and edge to edge to prevent cracking or cracks over time. It is a particular pyrolytic enamel, resistant to acids which, in addition to being pleasantly bright, promotes greater cleaning of the oven walls, thanks to its lower porosity. It is baked at over 850 ° C and slowly polymerized at a scientifically determined rate to ensure uniform depth and strength Ever Clean enamel creates an impeccable finish both on the inside of the oven and on the trays, making the surfaces of the oven incredibly easy to maintain over time as it reduces the adhesion of fat during cooking</p>
 <p>Fan assisted: Intense and homogeneous traditional cooking, also suitable for complex recipes. The fan is active and the heat comes from below and from above at the same time. Ventilated cooking ensures a faster and more homogeneous result, leaving fragrant foods outside and moister inside. Ideal for baked pasta, biscuits, roasts and cobblers.</p>	 <p>Static: Traditional cooking suitable for the preparation of one dish at a time. The fan is not active and the heat comes from below and from above at the same time. Static cooking is slower and more delicate, ideal in order to get well cooked and dry dishes even inside. Ideal for cooking all types of roasts, fatty meats, bread, filled cakes.</p>
 <p>Base: the heat comes only from the bottom of the cavity. The fan is not active. Ideal for sweet and savory pies, cobblers and pizzas. Designed to complete cooking and make food more crunchy This symbol in gas ovens indicates the gas burner.</p>	 <p>Circulaire: it is the perfect function for cooking all types of dishes in a more delicate way. The heat comes from the back of the oven and is distributed quickly and evenly The fan is active. It is also ideal for cooking on multiple levels without mixing smells and flavors.</p>
 <p>ECO: low energy consumption cooking: this function is particularly suitable for cooking on a single shelf with low energy consumption. It is recommended for all types of food except those that can generate a lot of moisture (for example vegetables). To achieve maximum energy savings and reduce time, it is recommended to put the food in the oven without preheating the cooking compartment</p>	 <p>Grill: Very intense heat coming only from above from a double heating element. The fan is not active. Provides excellent grilling and gratinating results. Used at the end of cooking, it gives a uniform browning to dishes.</p>
 <p>Fan grill: very intense heat coming only from above from a double heating element The fan is active. It allows the optimal grilling of thickest meats. Ideal for large cuts of meat.</p>	 <p>Turbo: the heat comes from 3 directions: above, below and from the back of the oven The fan is active. It allows quick cooking, even on several shelves without mixing the aromas. Ideal for large volumes or foods that require intense cooking.</p>
 <p>All glass inner door: All glass inner door, a single flat surface which is simple to keep clean.</p>	 <p>The inner door glass: can be removed with a few quick movements for cleaning.</p>



Side lights: Two opposing side lights increase visibility inside the oven.



Rapid preheating: cooking is preceded by the preheating phase which allows the cooking compartment to reach the set temperature. This option reduces the time by up to 50%.



The oven cavity has 5 different cooking levels.



Vapor Clean: a simple cleaning function using steam to loosen deposits in the oven cavity.



The capacity indicates the amount of usable space in the oven cavity in litres.



4.3 inch display with LED technology, usability with knobs + 3 touch keys